

**CS300-36**  
Planter Monitor

**MONOSEN**

OPERATORS' MANUAL

# TABLE OF CONTENTS

---



<b>Introduction</b> .....	<b>1</b>
System Overview .....	1
<b>Safety Notices</b> .....	<b>5</b>
<b>Major Features</b> .....	<b>7</b>
Performance .....	7
Console/Display .....	7
Compatibility .....	7
User Aid .....	7
<b>Key Overview</b> .....	<b>9</b>
On/Off .....	9
Alarm Cancel .....	10
Enter .....	10
Escape .....	10
Up and Down Arrows .....	11
Left and Right Arrows .....	11
Operate .....	11
Planter Setup .....	12
Ground Speed Setup .....	12
Limits Setup .....	12
Display & Service .....	13
Accessory Setup .....	13
Seed Count Mode .....	13
Speed Area Mode .....	14
<b>Installation</b> .....	<b>15</b>
Mounting Standard Bracket .....	15
Mounting Optional 3D Adjustable Bracket .....	16
Installing Console Harnesses .....	17
Installing Implement Harness and Sensors .....	18
<b>Quick Start Guide</b> .....	<b>19</b>
Planter Configuration .....	19
Ground Speed Configuration .....	20
To Perform a New Calibration .....	20
Manual Ground Speed Constant Entry .....	20
Help Card .....	20
<b>Set-Up</b> .....	<b>23</b>
Planter and Ground Speed (Mandatory Data Entry) .....	23
Row Set-Up (Auto Assigned) .....	24
Accessory (Optional) .....	24
Shaft/Fan Calibration .....	25
Flow Calibration .....	25
Limits Setup (Optional) .....	25
Display & Service Setup (Optional) .....	26
Auxiliary Modes .....	29
Speed, Area, Distance Mode .....	29
Seed Counting Mode .....	29



<b>Monitoring</b> .....	<b>31</b>
Main Screen .....	31
Parameter Outputs and Scrolling (Upper Screen Half) .....	31
Row Indicators (Lower Half) .....	32
Monitoring Functions .....	33
Average Population .....	33
Minimum/Average/Maximum Population .....	33
Population Row Scan .....	33
Average Spacing .....	34
Minimum/Average/Maximum Spacing .....	34
Spacing Row Scan .....	34
Average Seeds per Distance .....	34
Minimum/Average/Maximum Seeds per Distance .....	34
Seeds per Distance Row Scan .....	35
Field Area 1 .....	35
Field Area 2 .....	35
Total Area .....	35
Speed .....	35
Area per Hour .....	36
Fan .....	36
Shaft .....	36
Flow .....	36
<b>Alarms</b> .....	<b>37</b>
Row Blockage (Two Seeds per Second Threshold) — Solid ON Alarm .....	37
All Rows Failure — Eight Chirps .....	37
Hi or Low Limit Exceeded (Optional Limits for Population) — Alarm Chirp .....	38
Hi or Low Limit Exceeded (Optional Limits for Accessories) — Solid ON Alarm .....	38
Failed Ground Speed Sensor (Planting Detected Without Ground Speed) .....	39
Self-Test Failure (Battery Voltage Out of Limits) .....	39
Maximum Speed Exceeded (Optional) .....	40
<b>Troubleshooting</b> .....	<b>41</b>
Monitor Will Not Power On .....	41
Row Failure or Hi/Low Alarm when Row Is Planting Properly .....	41
Hopper Alarm Does Not Sound when Hopper Is Empty .....	42
Hopper Alarm Sounds when Hopper Is Full .....	42
System Voltage Alarm .....	42
Accessory Alarm Sounding when Shaft, Fan, or Flow Is Working .....	43
Ground Speed Alarm Sounds with Forward Movement .....	43
Ground Speed High Alarm Sounding .....	43
Self-Test Alarm .....	44
<b>Connector Pin-Outs</b> .....	<b>45</b>
<b>Parts Information</b> .....	<b>47</b>



## INTRODUCTION

### SYSTEM OVERVIEW

The Monosem CS-3000-36 Planter Monitor offers features to monitor up to 36 rows. The unit can monitor seed or fertilizer rows, two hopper levels, and a frequency input (shaft, fan, or flow). The unit stores all configuration data in nonvolatile memory, retaining information even when disconnected from power. Figure 1 shows the console.

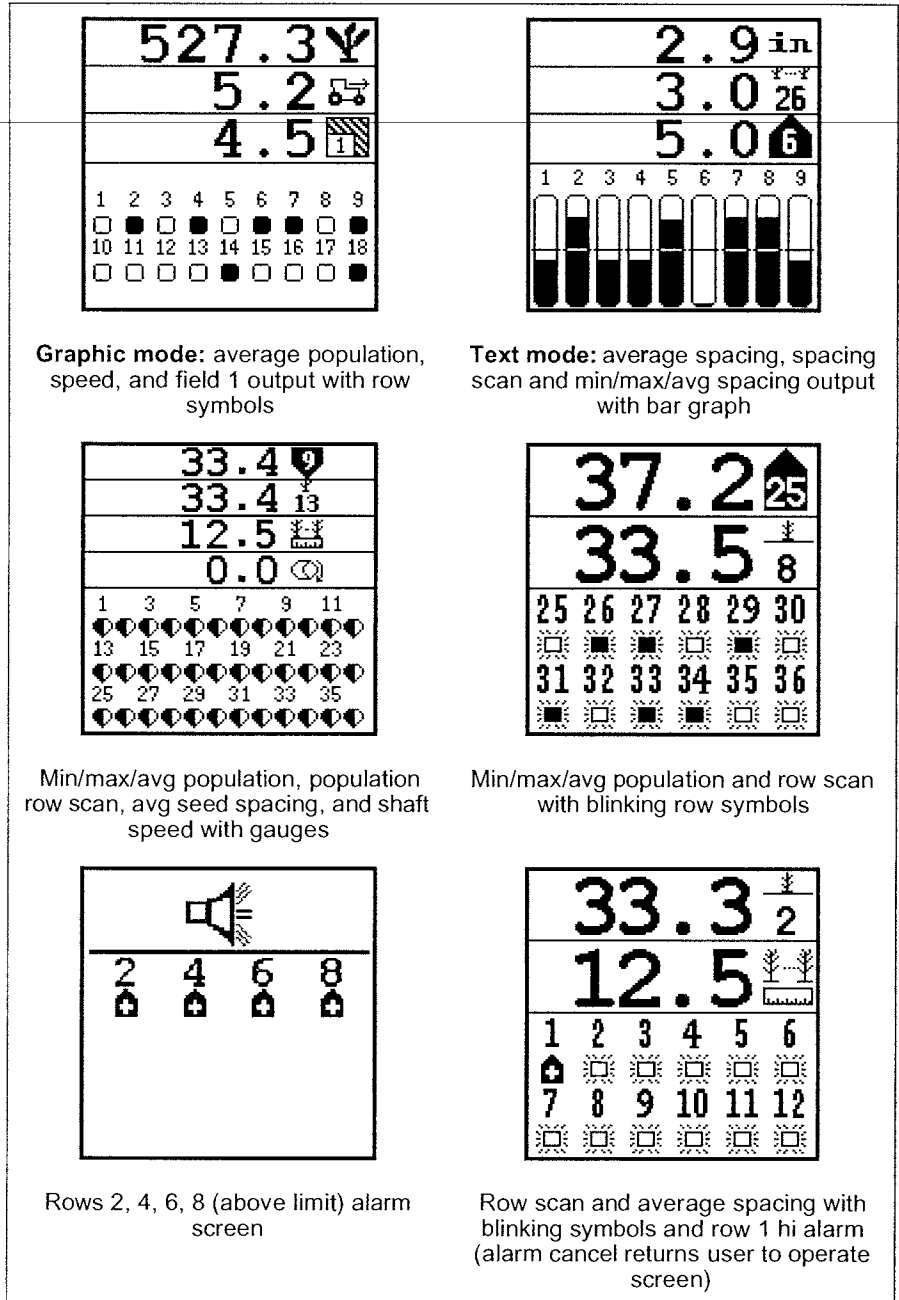
The CS-3000-36 is designed to meet custom needs of individual users. The display is configurable to output a comprehensive set of output planter parameters, but the user selects which parameters and the number of parameters they want to monitor. If the user prefers to monitor population and field area alone — those two parameters will be displayed in large, highly readable text. If the user desires more parameters, simply select them in the easy to navigate set-up. In any case, the user is in control of the data they need to view. Similarly, row information can be viewed in a bar graph, gauge, or symbol form. The information can be selected to be large (for ease of viewing), or small (for viewing the entire planter). Auto-scrolling and arrow key override are used to stay in control of the real-time information the user needs to see.

*Figure 1.*  
*CS-3000-36 Console*





Figure 2.  
User-Definable Display Examples



**Graphic mode:** average population, speed, and field 1 output with row symbols

**Text mode:** average spacing, spacing scan and min/max/avg spacing output with bar graph

Min/max/avg population, population row scan, avg seed spacing, and shaft speed with gauges

Min/max/avg population and row scan with blinking row symbols

Rows 2, 4, 6, 8 (above limit) alarm screen

Row scan and average spacing with blinking symbols and row 1 hi alarm (alarm cancel returns user to operate screen)



## SPECIFICATIONS

<b>Power</b>	10–16 VDC, 0.5 A maximum (8.0 A maximum with 16 seed sensors)
<b>Operating temperature range</b>	-20°C to 70°C (-4°F to 158°F)
<b>Storage temperature range</b>	-40°C to 85°C (-40°F to 185°F)
<b>Size</b>	18.4 cm W x 18.4 cm H x 18.0 cm D (7.3" W x 7.3" H x 7.1" D)
<b>Weight</b>	6.8 kg (15 lb) for 16-row CS-3000-36 system
<b>Wire Harnesses</b>	The CS-3000-36 includes integrated harnesses to supply the unit's power (fused), ground speed input, and sensor inputs (to hitch).
<b>Sensors</b>	Compatible with existing DICKEY-john sensors
<b>Standard mounting</b>	Rear attached horizontal or vertical mounting bracket
<b>Optional mounting</b>	Three-axis adjustable mounting bracket
<b>Contrast adjustment</b>	Automatic temperature compensation for contrast
<b>Backlight adjustment</b>	Three settings for full sun, daytime, or nighttime use
<b>CE certified</b>	
<b>Dust and moisture resistant</b>	

**MONOSEM**

## SAFETY NOTICES

Safety notices are one of the primary ways to call attention to potential hazards.



This Safety Alert Symbol identifies important safety messages in this manual. When you see this symbol, carefully read the message that follows. Be alert to the possibility of personal injury or death.



---

Use of the word **WARNING** indicates a potentially hazardous situation which, if not avoided, could result in death or serious injury.

---



---

Use of the word **CAUTION** with the safety alert symbol indicates a potentially hazardous situation which, if not avoided, may result in minor or moderate injury.

---



---

Use of the word **CAUTION** without the safety alert symbol indicates a potentially hazardous situation which, if not avoided, may result in equipment damage.

---



## MAJOR FEATURES

### PERFORMANCE

- Planter monitoring of 36 rows
- Monitoring of ground speed, two hopper levels, one frequency function (fan, shaft, or flow)
- Easy and flexible configuration
- User definable viewing of two, three, or four functions (all can be selected):
  - Average Population
  - Average Seed Spacing
  - Average Seeds per Distance (m/ft)
  - Population Row Scan
  - Seed Spacing Row Scan
  - Seed per Distance Row Scan
  - Minimum, Maximum, Average Row Population
  - Minimum, Maximum, Average Row Spacing
  - Minimum, Maximum, Average Spacing per Distance
  - Field Area 1
  - Field Area 2
  - Total Area 3
  - Ground Speed
  - Fan, Shaft, or Flow Frequency
- User definable row information:
  - Bar Graph
  - Wiper Gauge
  - Symbols
  - Symbols flashing proportional to seeding rates

### CONSOLE/DISPLAY

- Large, user friendly keys
- User definable text sizes for ease of reading
- Graphical or text-based output labels
- Backlit graphical display for nighttime use
- Three-level backlight intensity adjustment
- Large, concise error messages on display with audible alarm
- English or metric units
- Horizontal and vertical mounting (optional 3D adjustment bracket)

### COMPATIBILITY

- Compatible with DICKEY-john sensors
- Plug-in replacement for DICKEY-john monitors
- Optional support of RS-232 based data logging

### USER AID

- Help card





## KEY OVERVIEW

Figure 3  
CS-3000-36 Keys



### ON/OFF



The unit activates when the ON/OFF key is pressed. At power up, the monitor performs internal self-tests, illuminates the display, sounds the alarm, and determines which sensors are connected to the system. Pressing and holding the key for one second when power is on will power OFF the system, independent of the screen being displayed.



## ALARM CANCEL



During normal operation, pressing the ALARM CANCEL key acknowledges the alarm conditions that are displayed on the screen. Active row alarms are reset after an All Rows Failure condition or a power down-up sequence occurs. If the error condition remains after reset, the key must be pressed again to cancel the alarm. When no alarms are active, volume can be modified by pressing and holding the ALARM CANCEL key.

## ENTER



Pressing the ENTER key selects a sub-menu (display and service screen) or selects the highlighted item for data modification. After changing the parameter values, ENTER accepts the modified data.

## ESCAPE

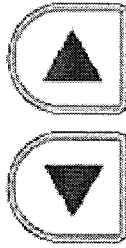


In the MAIN OPERATE SCREEN, pressing and holding the ESCAPE key for two seconds will clear an area accumulator if it is located on the top line of the display.

When navigating through sub-menus, the ESCAPE key moves the user back one selection. After changing parameter values, pressing ESCAPE accepts the modified data.

**MONOSEM**

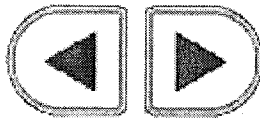
## UP AND DOWN ARROWS



In the MAIN SCREEN, the UP and DOWN arrow keys are used to manually select the parameters being viewed at the top of the display. They are inactive if all parameters are already displayed (number of parameters are equal to or less than number of lines).

When in the MAIN MENU screen, the arrows are used to navigate between options. When in a particular set-up screen, the arrows are used to navigate between options or to change a digit/option.

## LEFT AND RIGHT ARROWS



In the MAIN SCREEN, the LEFT and RIGHT arrow keys are used to manually select the rows being viewed in the bottom of the display. They are inactive if all rows are already displayed. When in the MAIN MENU or in a particular screen, the arrows are used to navigate between options.

## OPERATE



The OPERATE (HOME) key is used to return the user to the MAIN SCREEN. If data is changed, it is saved when this key is pressed.

## PLANTER SETUP



The PLANTER SETUP key is used to navigate the user to the PLANTER SETUP for input of the:

- number of rows
- row spacing
- implement width (optional)
- row type (population — default, blockage, skipped, or disabled)

If data in another screen is changed, it is saved when this key is pressed.

## GROUND SPEED SETUP



The GROUND SPEED SETUP key is used to navigate the user to the GROUND SPEED SETUP for:

- running a ground speed calibration (or manual entry of ground speed calibration number)
- manual ground speed (used if no ground speed is available)
- ground speed maximum limit (optional)

If data in another screen is changed, it is saved when this key is pressed.

## LIMITS SETUP



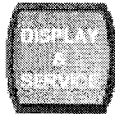
The LIMITS SETUP key is used to navigate the user to the LIMITS SETUP for input of the:

- upper limit (optional)
- target population value (optional)
- lower limit (optional)
- population adjustment factor (optional for sensors that count less than 100% of all seeds)
- response rate (optional to increase or decrease the console's response rate)

If data in another screen is changed, it is saved when this key is pressed.



## DISPLAY & SERVICE



The DISPLAY & SERVICE key is used to navigate the user to the DISPLAY & SERVICE SETUP for:

- access to the function, row indicators, service, and security sub-menus
- English/Metric units selection
- display backlight intensity
- alarm volume

If data in another screen is changed, it is saved when this key is pressed.

## ACCESSORY SETUP



The ACCESSORY SETUP key is used to navigate the user to the ACCESSORY SETUP for:

- selection of a fan (RPM) / shaft (RPM) / or flow (G/MIN or L/min) labels
- upper and lower alarm limit
- calibration (or manual calibration number entry)

If data in another screen is changed, it is saved when this key is pressed.

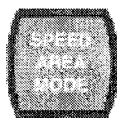
## SEED COUNT MODE



The SEED COUNT MODE key is used to navigate the user to the SEED COUNT screen. This mode allows users to test planters for proper operation prior to field use. If data in another screen is changed, it is saved when this key is pressed.



## SPEED AREA MODE



The SPEED AREA MODE key is used to navigate the user to the SPEED AREA DISTANCE screen. This mode allow users to use the console for non-planting operations. The mode is also used to start, stop, or clear the three independent area accumulators (Field area 1, Field area 2, and Total area). If data in another screen is changed, it is saved when this key is pressed.

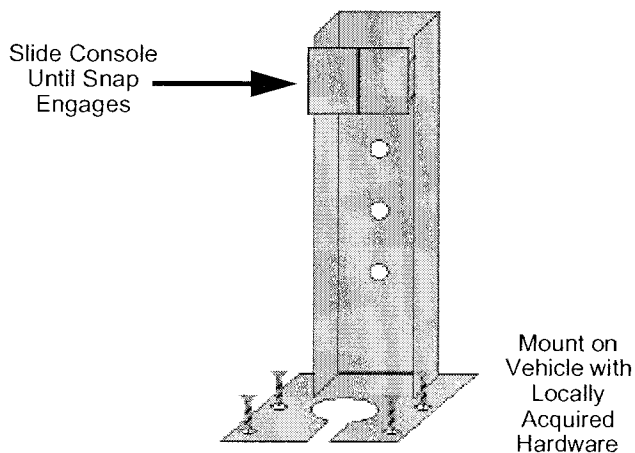


## INSTALLATION

Before shipping, the monitor is tested and inspected to ensure the unit is fully operational and meets all measurement specifications. After unpacking, inspect for damage that may have occurred during transit. Save all packing materials until inspection is complete. If damage is found, immediately file a claim with the carrier. Also notify your Monosem Sales Representative.

### MOUNTING STANDARD BRACKET

*Figure 4*  
*Mounting Bracket Installation*



#### **WARNING**

The console must not obstruct the view of the operator or interfere with the operation of the tractor.

#### **CAUTION**

To prevent damage to the console, be sure the snap fully engages during installation.

*NOTE: When mounted to a vertical surface, a tie-wrap can be used to retain the cables to the bottom of the bracket.*

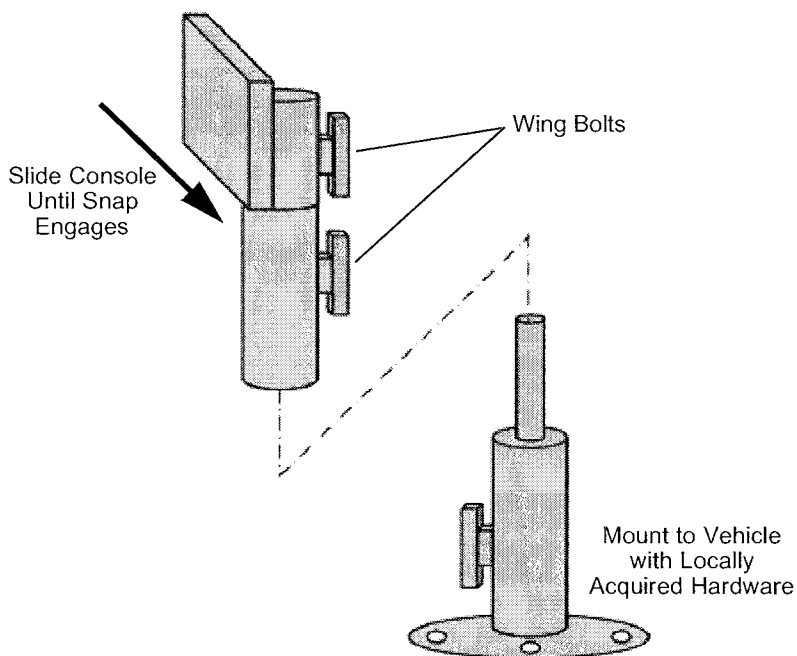
Install the mounting bracket at the location of your choice using locally acquired hardware. Install the console to the bracket by aligning the console mating grooves with the bracket, and sliding the console onto the bracket until the snap engages.



## MOUNTING OPTIONAL 3D ADJUSTABLE BRACKET

Figure 5

3D Mounting Bracket Installation



### **WARNING**

The console must not obstruct the view of the operator or interfere with the operation of the tractor.

### **CAUTION**

To prevent damage to the console, be sure the snap fully engages during installation.

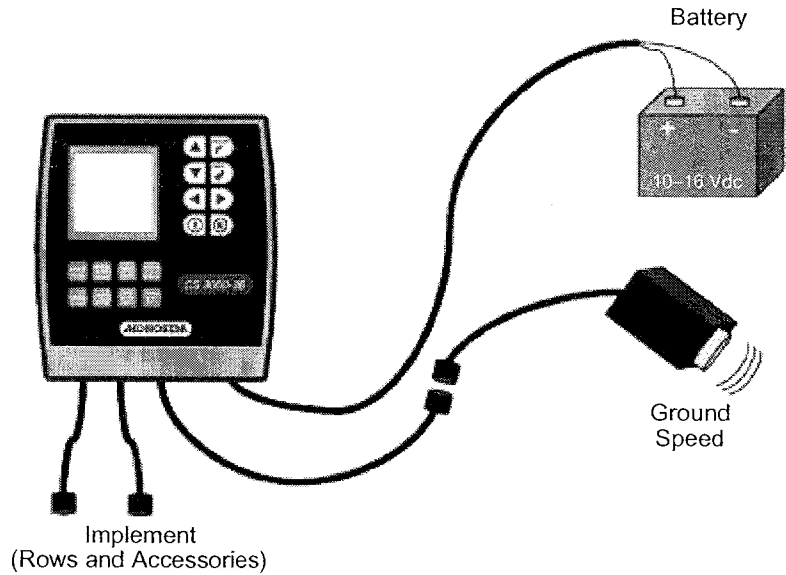
Separate the bracket halves from one another by loosening the wing bolt. Install the upper bracket half into the console by sliding the bracket's rectangular section into the console mating grooves until the snap engages. Install the bottom bracket half at the location of your choice using locally acquired hardware.





## INSTALLING CONSOLE HARNESSSES

Figure 6  
Console Harnesses



Several harnesses are located at the bottom of the CS-3000-36. These include power, ground speed sensor, and sensor inputs (rows, lift switch, two hopper levels, and one frequency function [shaft/fan/flow]).

### STEP 1

Route the power harness to a +12 V source near the battery if possible.

### STEP 2

Route the ground speed sensor harness connection to the RADAR, Hall Effect, or GPS ground speed sensor.

### STEP 3

Route the implement harness to the location of your choice, typically near the hitch.

## WARNING

The harnesses must not obstruct movement of the operator or of the moving parts of the tractor or implement. Take care when routing harnesses to secure them at proper locations; provide slack as needed to allow for movement.

## CAUTION

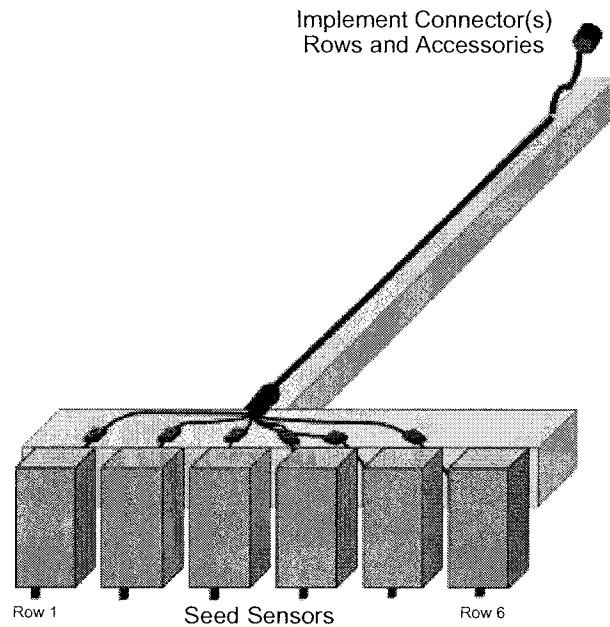
Poor +12 V connections can cause intermittent console operation. Be sure to connect the power harness to a clean, well-conditioned source (direct battery connection is best).



## INSTALLING IMPLEMENT HARNESS AND SENSORS

*Figure 7*

*Implement Harness*



The implement harness provides the custom fit and functions required by the implement. Each harness branch is labeled for the location (row 1, row 2, etc.) or sensor (lift switch) that it must be routed to for connection. Some sensors may require special adapters for connection.

### **STEP 1**

Install sensors onto seed tubes using tie-wraps.

### **STEP 2**

Route implement harness to the appropriate locations; provide slack near moving parts to allow for movement. Attach harness to the implement using tie-wraps.

### **STEP 3**

Make sure the hitch connections will connect to the tractor connections with the proper amount of slack for implement movement.

## **CAUTION**

**The harnesses must not obstruct moving parts of the tractor or implement. Take care when routing harnesses to retain them at proper locations with adequate slack for movement.**



## QUICK START GUIDE

Three inputs are required for monitor operation.

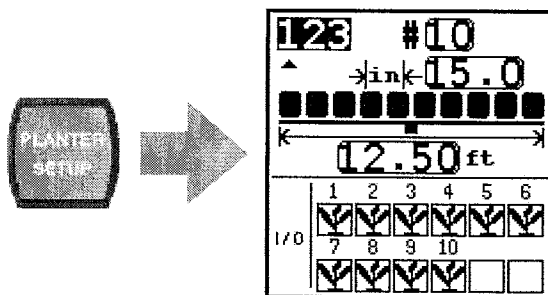
- Number of rows
- Row spacing
- Ground speed constant

Selecting a pre-programmed planter configuration provides easy set-up of planter row width, number of rows, implement width, and row types.

### PLANTER CONFIGURATION

To program the PLANTER configuration, press the PLANTER SETUP key. The PLANTER configuration screen will be displayed (Figure 8).

*Figure 8*  
*Planter Set-Up Screen*



The CS-3000-36 can store three planter configurations for users with split row planters or multiple planters and seeders. Many users will program only a single configuration. Select a planter configuration number (1, 2, or 3) by moving the selection arrow indicator (▲). Use the ARROW keys to highlight the number of rows. Press ENTER to modify the number of rows. Use the ARROW keys to select digits, increment, and decrement values. Press ENTER to accept the new number. Enter the row spacing in the same manner. Once the new values are entered, press ESCAPE or OPERATE to return to the MAIN SCREEN.

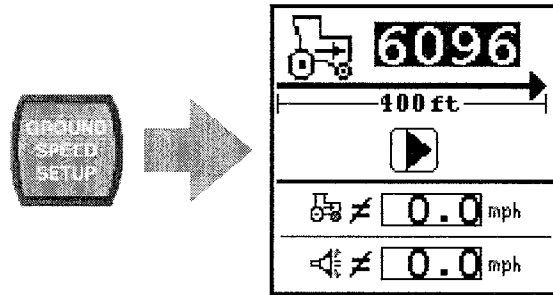


## GROUND SPEED CONFIGURATION

To select the GROUND SPEED screen, press GROUND SPEED SETUP key. The GROUND SPEED configuration screen will be displayed (Figure 9).

**Figure 9**

*Ground Speed Set-Up Screen*



### TO PERFORM A NEW CALIBRATION

Highlight the START soft key (▶) using the ARROW keys. Press ENTER to start the 400-foot calibration. After the calibration is started, the button will change to a STOP (■) soft key. Drive 400 feet and stop the vehicle. Press ENTER to STOP the calibration. The new calibration factor will be shown in the window. Press ENTER to accept this value or ESCAPE to reject the value. Press ESCAPE or OPERATE to return to the MAIN SCREEN.

### MANUAL GROUND SPEED CONSTANT ENTRY

Use the ARROW keys to highlight the manual ground speed value. Press ENTER to modify the constant. Use the ARROW keys to select digits, increment, and decrement values. Press ENTER to accept the new number. Once the new values are entered, press ESCAPE or OPERATE to return to the MAIN SCREEN. Any non-zero value will activate manual ground speed. Set manual ground speed to zero to disable.

*NOTE: To verify that the correct calibration number has been obtained, move to the speed/area/distance screen. Verify that the speed matches the vehicle's speedometer or remeasure the 400-foot distance.*

### HELP CARD

This help card can be cut out for a compact reference for definitions, set-up screens, and general operating information (Figure 10).

# OPERATOR'S MANUAL



Figure 10  
Help Card

				<b>Display &amp; service menus</b>		
Planter	Ground Speed	Limits	Display and service			
				Functions (top half)	Service	
Operate (Home)	Accessories	Seed Count	Speed Area Distance			
<p>Use keys to select screen Use ▲▲▼▼ (arrow keys) to select item Use ENTER to modify highlighted item</p> <p>Use ▲▲▼▼ (arrow keys) to change items / digits or to select digits</p> <p>Use ENTER to accept data or OPERATE to accept data and return to the OPERATE screen</p>				Rows output (bottom half)	Security	
	Population	Seed Spacing	Seeds per Distance	Field Area 1	Field Area 2	Total Area
Average						
Row Scan	Population	Seed Spacing	Seeds per Distance	Speed	Area/hour	Distance
Minimum						
Maximum	Population	Seed Spacing	Seeds per Distance	Shaft	Fan	Flow
Average						
Warning	Hi/Lo	No flow	Hopper	All Rows Failed	Planter Lifted	No Speed Input
Start	Stop	Reset	Security	Password	Save Password	Configuration
Alarm	English / Metric	Back light	Graphic / Text Label	Population adjust	Response rate	



## SET-UP

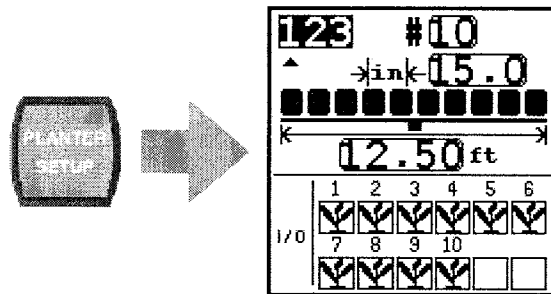
The monitor is designed to be easy for basic monitoring by new users, while supporting an expanded set of features for advanced users. In either case, the user decides which features to configure.

### PLANTER AND GROUND SPEED (MANDATORY DATA ENTRY)

There are two set-up screens that require inputs for the system to function as a monitor, PLANTER (Figure 11) and GROUND SPEED (Figure 12).

Figure 11

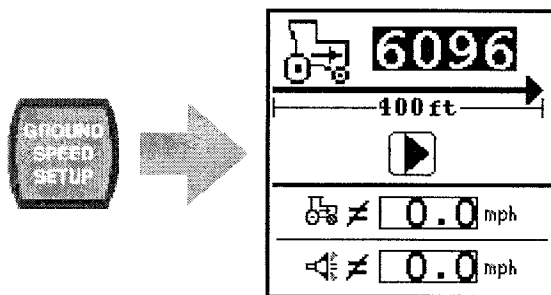
Planter Set-Up Screen



The PLANTER set-up screen must include the number of rows and the row spacing or implement width for the console to properly display population. The user can pre-program up to three different configurations. This supports users with split row planters (configuration 1 for normal and 2 for split row) and a separate seeder or drill (configuration 3).

Figure 12

Ground Speed Set-Up Screen





The GROUND SPEED set-up screen must include a calibration factor for proper calculation and display of ground speed. Also included in the GROUND SPEED set-up screen are a calibration aid, a manual ground speed value, and a maximum speed alarm. The calibration aid can be used to measure the calibration factor, which is the number of pulses in 122 m (400 ft). The manual ground speed (optional) can be used when a ground speed sensor is not installed or has failed in the field. The maximum speed alarm (optional) provides the user with an over-speed alarm.

## ROW SET-UP (AUTO ASSIGNED)

The console will automatically assign the number of rows defined in the PLANTER set-up screen as ON.

Rows can be configured to be ON, OFF (split row), FLOW, or DISABLED.

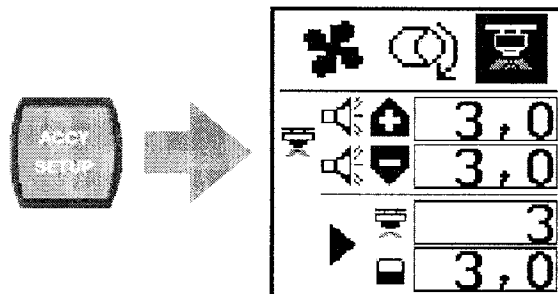
- When ON is selected (plant), the row is active and the console will detect sensors and seed flow.
- When OFF is selected (blank), the row is removed and remaining rows are re-numbered. This is used for split row systems where every other row or sets of internal rows are not planting. Their corresponding row number is ignored, allowing for true planting operations to be displayed on the monitor.
- When DISABLED is selected (circle with slash), the row input is ignored. The row number will be displayed. This is used when a row or sensor is malfunctioning and the operator wants to disable monitoring on that row.
- When FLOW is selected (funnel), the row will not be included for population calculations, but will be monitored for flow. The flow rows will be used to detect flow (fertilizer or seeds) and alarm if the flow falls below two pulses per second.

## ACCESSORY (OPTIONAL)

To add an auxiliary sensor and its performance characteristics (calibration values, limits, etc.) to the monitoring inputs, it must be activated by entering a calibration constant. If minimum or maximum alarms are desired, the limits can be added to the calibrated sensors. A fan, shaft, or flow sensor can be monitored with hi and/or low alarms or no alarm values.

*Figure 13*

**Accessory Screen**





## SHAFT/FAN CALIBRATION

Start the calibration by highlighting the start icon (arrow) and depressing ENTER. The arrow will change to a square and the calibration factor area will begin to accumulate. While counting the revolutions, turn the shaft or fan a whole number of revolutions. Stop the calibration by depressing ENTER (keep square highlighted — it will change back to an arrow). The calibration factor area will stop accumulating. Using arrow keys, highlight the revolutions box (below calibration number) and enter the number of revolutions turned.

## FLOW CALIBRATION

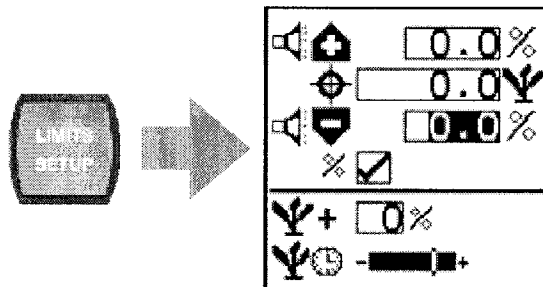
A method is required to determine the volume of material dispensed is required (weight, sight glass, or catch buckets). Start the calibration by highlighting the start icon (arrow) and depressing ENTER. The arrow will change to a square and the calibration factor area will be ready to accumulate. Activate liquid dispensing (water is recommended). Once a desired amount of water is dispensed, turn off dispensing. The calibration factor area will stop accumulating. Stop the calibration by depressing ENTER (keep square highlighted — it will change back to an arrow). Measure the amount of liquid that was dispensed. Using arrow keys, highlight the tank volume box (below calibration number) and enter the number of gallons (liters) dispensed.

## LIMITS SETUP (OPTIONAL)

The LIMITS SETUP screen allows the user to define several population features (Figure 14). The user can define a target population. If no value is selected, the monitor will use the average population as a calculation for alarms and row indicators. Minimum and maximum limits can be assigned with either percentage or value based entries. If the % box is checked, the entry is percentage based, otherwise it is value based. A population adjustment factor is available to provide a means to display populations nearer the actual than the sensed seeding rates. This is useful when sensors do not detect doubles, triples, etc. Lastly, the population response rate is also selectable. This feature is used to provide population display stability for planters with few rows versus planters with many. Slide to right for high seeding rates and to left for low seeding rates.

*Figure 14*

*Limits Setup Screen*







## DISPLAY & SERVICE SETUP (OPTIONAL)

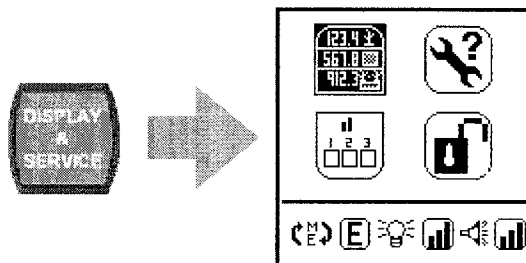
A primary consideration in the CS-3000-36 design is the ability to provide the flexibility in display information to fit the needs of individual operators. The DISPLAY & SERVICE SETUP screen is used to customize the display to include only the information the operator desires (Figure 15). Factory default selections are set for typically desired parameters for basic monitoring. However, the broad range of CS-3000-36 input features has the ability to allow the user to define the information available for viewing and the size of the information (small, medium, or large).

The display includes two sets of icons. The upper set includes icons for upper screen set-up, lower screen set-up, security and service. The lower set includes icons for configuration of Metric/English, alarm volume and backlight intensity.

The Metric/English allows the operator to select the units that they prefer. The alarm volume and backlight intensity have three levels of adjustment each.

**Figure 15**

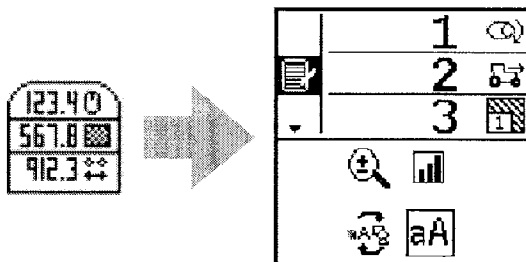
*Primary User Interface Screen*



The upper screen parameters can be modified by selecting the upper screen icon and pressing ENTER. Once the upper screen is entered, the upper half of the display is used for parameter selection while the lower half is used for changing text sizes or switching between graphic and text displays (Figure 16). The graphic/text mode allows the operator to view graphic symbols or text-based labels (i.e., versus MPH). The bar selection causes the text size to be large, medium, or small, respectively. Default value is three lines (medium).

**Figure 16**

*Upper Screen Parameters Screen*





The user can select which parameter to be displayed in numerical order from the following list. (Also refer to "Monitoring Functions" on page 33).

- Average Population
- Average Seed Spacing
- Average Seeds per Distance (m/ft)
- Population Row Scan
- Seed Spacing Row Scan
- Seed per Distance Row Scan
- Minimum, Maximum, Average Row Population
- Minimum, Maximum, Average Row Spacing
- Minimum, Maximum, Average Spacing per Distance
- Field Area 1
- Field Area 2
- Total Area 3
- Ground Speed
- Fan, Shaft, or Flow Frequency

Default values are three parameters that include 1 = average population, 2 = seed spacing row scan, 3 = field area 1.

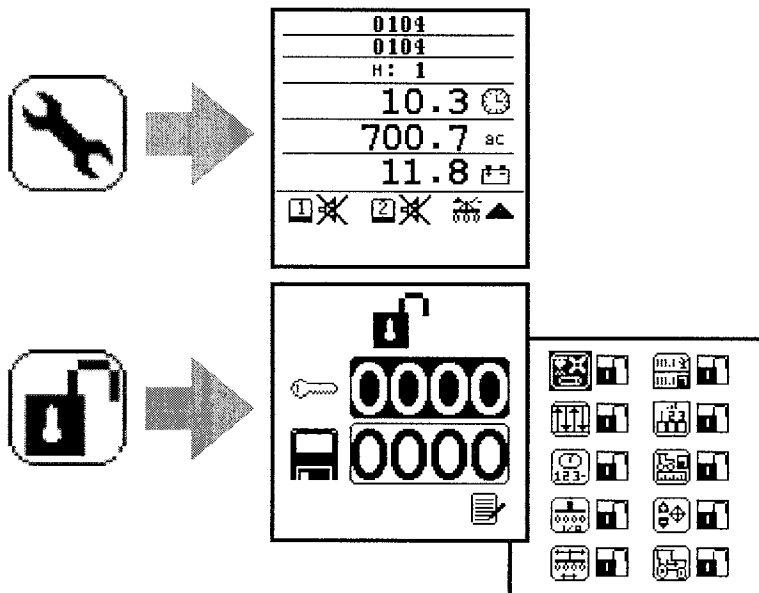
The security feature allows the CS-3000-36's password protected security levels to be activated (Figure 17). This prevents unauthorized personnel from modifying key parameters in the field. Defaults are text, English, high volume, medium backlight, and unlocked security.

The service screen shows hardware and software versions, total hours of operation, total acres covered, battery voltage, hopper level 1 & 2 sensor status, and lift switch status.

The password screen allows the operator to individually lock screens to assure they are not modified. Using the arrow keys, highlight the disk icon and depress enter to enter a password. Modify the digits and depress enter to accept the password. Select the menu icon to navigate to the list of screens. Lock or unlock screens as desired. Depress escape to return to the password screen. Highlight the padlock and depress enter to toggle the unlocked state to locked. The screens selected to be locked will require input of the password prior to modification.

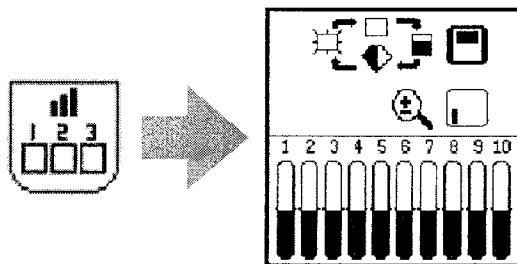


Figure 17  
Service and Security Screens



The lower screen parameters (Figure 18) can be modified by selecting the lower screen icon and pressing ENTER. The row indicator type can be selected in the top selector. Types include blinking box (blink rate proportional to seeding rate), solid box, bar graph, or wiper gauge. These can be displayed in a small, medium, or large size, which is the next selection item. The size determines the number of rows that can be displayed on the bottom half of the display. Default is non-blinking box, medium size.

Figure 18  
Lower Screen Parameters Screen





## AUXILIARY MODES

**NOTE:** Alarms are disabled in these modes.

The monitors provide modes for alternative monitor use and row unit testing.

**NOTE:** A lift switch can be used to more accurately monitor acre accumulators and is required for acreage monitoring in non-planting operations.

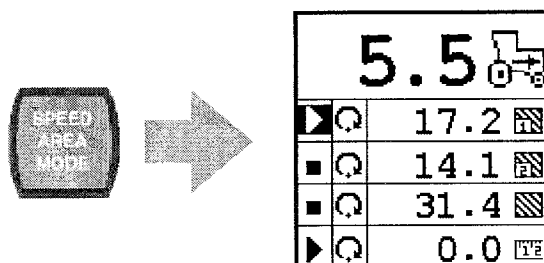
### SPEED, AREA, DISTANCE MODE

The SPEED, AREA, DISTANCE mode can be used for cultivating (Figure 19). This mode includes start/stop/reset for Field area 1, Field area 2, Total area (hc3/ac3), and distance.

If a manual ground speed is selected, the area and distance will not accumulate in this mode.

**Figure 19**

**Speed, Area, Distance Screen**

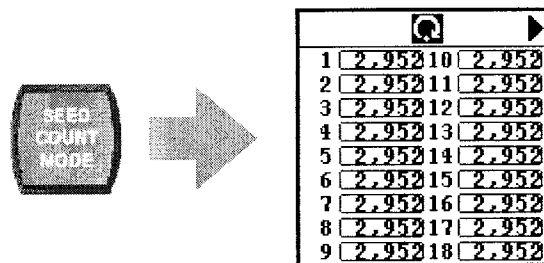


### SEED COUNTING MODE

The SEED COUNTING mode can be used to determine row unit performance when operating the planter in a stationary manner. A reset for all rows is included (Figure 20).

**Figure 20**

**Seed Counting**





## MONITORING

### MAIN SCREEN

The CS-3000-36's MAIN SCREEN provides the monitoring functions. No matter where a user has navigated in the set-up, security, or auxiliary modes, they can press the OPERATE key or repeatedly press the ESCAPE key to return to the main screen.

The MAIN SCREEN is divided into two halves, upper and lower. The upper half provides user definable output parameters (population, area, speed, etc.) while the lower half is dedicated to row information.

### PARAMETER OUTPUTS AND SCROLLING (UPPER SCREEN HALF)

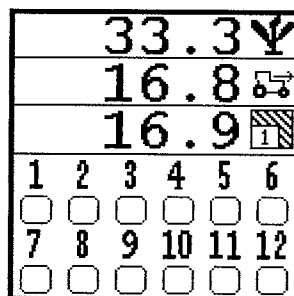
Through the User Interface settings, it is possible for more parameters to be selected than can be displayed on the screen. If more parameters are selected than are available, the UP and DOWN arrow keys are used to scroll between the parameters. This function provides wrapping. As an example, if five parameters are selected:

- 1 = Average population
- 2 = Speed
- 3 = Field area
- 4 = Total area
- 5 = Shaft rpm

If the screen were configured to display three items, the main screen would display average population, speed, and field area (Figure 21). When the DOWN arrow is pressed, the screen would display items 2, 3, and 4. Pressing the DOWN arrow a second time would display items 3, 4, and 5.

**Figure 21**

*Three-Item Display Configuration*

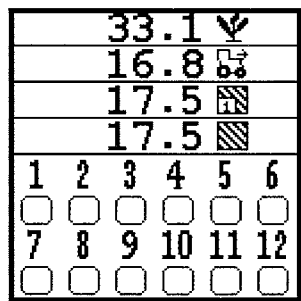




If the screen were configured to display four items, average population, speed, field area, and total area would be shown (Figure 22).

**Figure 22**

*Four-Item Display Configuration*

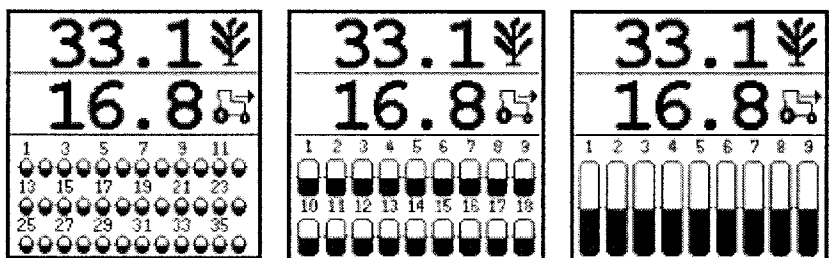


## ROW INDICATORS (LOWER HALF)

The number of rows displayed in the lower half are user definable. When more rows are ON than are viewable, the monitor automatically scrolls through the rows at three-second intervals (bar graph with 36-row machine). The operator can use the RIGHT and LEFT arrow keys to manually select the desired rows. The automatic scrolling will restart 10 seconds after a manual selection. Similar to parameters display, row indicators can be small, medium, or large (Figure 23).

**Figure 23**

*Row Indicators*



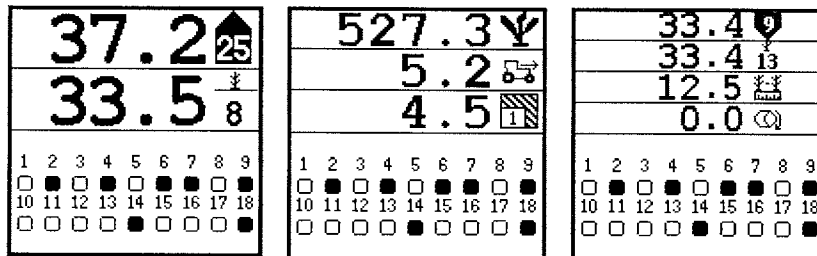


## MONITORING FUNCTIONS

The operator can choose to simultaneously view two, three or four monitoring or control functions (Figure 24) and may select several more that require a touch of an arrow key to view. Factory default parameters are population, spacing, and field area.

Figure 24

Display of Two, Three or Four Parameters



### AVERAGE POPULATION



The AVERAGE POPULATION function displays the average of the planter's rows that are configured for population in seeds per hectare (s/ha) or seeds per acre (s/ac). The population response rate and population adjustment can be modified in the target set-up screen. This function can be labeled with a symbol or text, depending on the text/graphic setting.

### MINIMUM/AVERAGE/MAXIMUM POPULATION



The MINIMUM/AVERAGE/MAXIMUM POPULATION function alternates the display of the minimum row, planter average, and maximum row every two seconds. When a minimum or maximum row is being displayed, the corresponding symbol is shown with the row number.

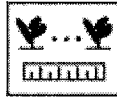
### POPULATION ROW SCAN



The POPULATION ROW SCAN function displays the population of each of the planter's rows. The console increments the displayed row every two seconds. After the last row is displayed, the console returns to the first active row for another scan sequence.



## AVERAGE SPACING



The AVERAGE SPACING function displays the average seed spacing (cm or in.) of the planter's rows that are configured for population. This function can be labeled with a symbol or text, depending on the text/graphic setting.

## MINIMUM/AVERAGE/MAXIMUM SPACING



The MINIMUM/AVERAGE/MAXIMUM SPACING function alternates the display of the minimum row, planter average, and maximum row every two seconds. When a minimum or maximum row is being displayed, the corresponding symbol is shown with the row number.

## SPACING ROW SCAN



The SPACING ROW SCAN function displays the spacing of each of the planter's rows. The console increments the displayed row every two seconds. After the last row is displayed, the console returns to the first active row for another scan sequence.

## AVERAGE SEEDS PER DISTANCE



The AVERAGE SEEDS PER DISTANCE function displays the average seeds per meter (s/m) or seeds per foot (s/ft) of the planter's rows that are configured for population. This function can be labeled with a symbol or text, depending on the text/graphic setting.

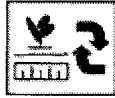
## MINIMUM/AVERAGE/MAXIMUM SEEDS PER DISTANCE



The MINIMUM/AVERAGE/MAXIMUM seeds per distance function alternates the display of the minimum row, planter average, and maximum row every two seconds. When a minimum or maximum row is being displayed, the corresponding symbol is shown with the row number.

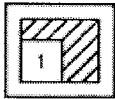


### SEEDS PER DISTANCE ROW SCAN



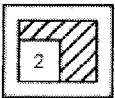
The SEEDS PER DISTANCE ROW SCAN function displays the seeds per distance of each of the planter's rows. The console increments the displayed row every two seconds. After the last row is displayed, the console returns to the first active row for another scan sequence.

### FIELD AREA 1



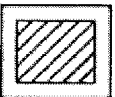
The FIELD AREA 1 (ha1/ac1) function displays the area of Field 1 in hectares (ha) or acres (ac), depending on the English/Metric setting. This function can be labeled with a symbol or text, depending on the text/graphic setting.

### FIELD AREA 2



The FIELD AREA 2 (ha2/ac2) function displays the area of Field 2 in hectares (ha) or acres (ac), depending on the English/Metric setting. This function can be labeled with a symbol or text, depending on the text/graphic setting.

### TOTAL AREA



The TOTAL AREA (ha3/ac3) function displays the total field area in hectares (ha) or acres (ac), depending on the English/Metric setting. This function can be labeled with a symbol or text, depending on the text/graphic setting.

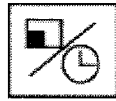
### SPEED



The SPEED function displays the vehicle speed in miles per hour (mph) or kilometers per hour (km/h), depending on the English/Metric setting. This function can be labeled with a symbol or text, depending on the text/graphic setting.



## AREA PER HOUR



The AREA PER HOUR function displays the current rate of area per hour in hectares per hour (ha/hr) or acres per hour (ac/hr), depending on the English/Metric setting.

## FAN



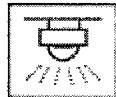
The FAN function displays the fan's speed in revolutions per minute (rpm).

## SHAFT



The SHAFT function displays the shaft's speed in revolutions per minute (rpm).

## FLOW



The FLOW function displays the flow rate speed in liters per hectare (l/ha) or gallons per acre (g/ac), depending on the English/Metric setting.



## ALARMS

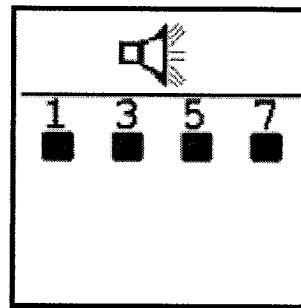
*NOTE: An audible 2-chirp alarm is also output during navigation or data entry to indicate an illegal or non-functional key press.*

Primary operating alarms are displayed using the entire screen and are accompanied by an audible alarm. Hopper level alarms are depicted as HL1 or HL2. These alarms include:

### ROW BLOCKAGE (TWO SEEDS PER SECOND THRESHOLD) — SOLID ON ALARM

*Figure 25*

*Row Blockage Display*

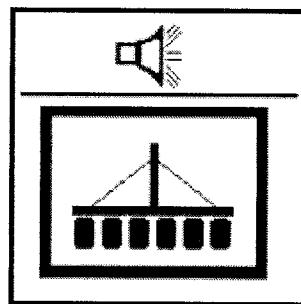


### ALL ROWS FAILURE — EIGHT CHIRPS

*NOTE: A lift switch can be used to override this alarm.*

*Figure 26*

*All Rows Failure Display*

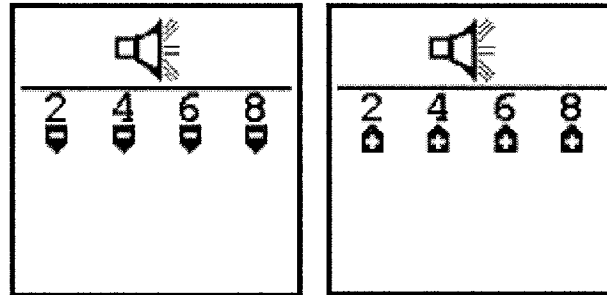




HI OR LOW LIMIT EXCEEDED (OPTIONAL LIMITS FOR POPULATION) — ALARM CHIRP

Figure 27

Population Limit Warning Display



HI OR LOW LIMIT EXCEEDED (OPTIONAL LIMITS FOR ACCESSORIES) — SOLID ON ALARM

Figure 28

Fan Speed Limit Warning Display (Optional)

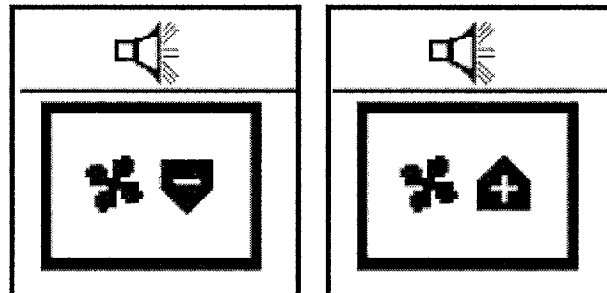


Figure 29

Shaft Speed Limit Warning Display (Optional)

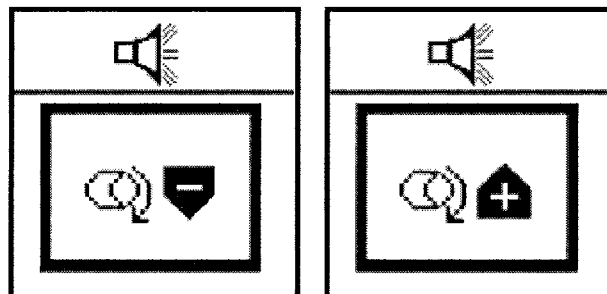
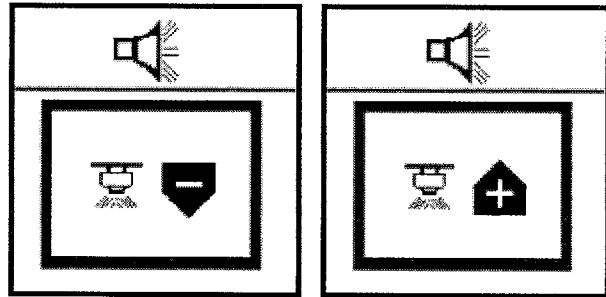




Figure 30

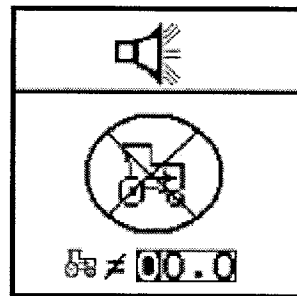
Pressure Hi Limit Warning Display (Optional)



FAILED GROUND SPEED SENSOR (PLANTING DETECTED WITHOUT GROUND SPEED)

Figure 31

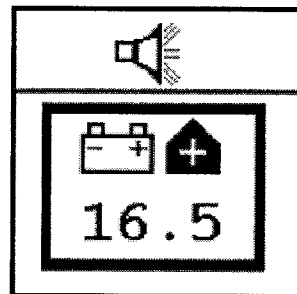
Ground Speed Sensor Failure Display



SELF-TEST FAILURE (BATTERY VOLTAGE OUT OF LIMITS)

Figure 32

Self-Test Failure Display



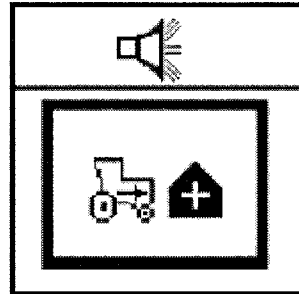


## MAXIMUM SPEED EXCEEDED (OPTIONAL)

*Figure 33*

*Maximum Speed Exceeded Warning Display (Optional)*

---





## TROUBLESHOOTING

### MONITOR WILL NOT POWER ON

#### Probable Cause

1. Blown console fuse
2. Poor battery connection
3. Low battery voltage
4. Defective console

#### Corrective Action

1. Check fuse (located near battery connection). If needed, replace with 7.5 A fuse maximum. If fuse blows again, check all harnesses for pinches or breaks that may cause power short to ground.
2. Be sure connections are clean and tight. Inspect harness for damage.
3. Console voltage must be at least 10 V. If low, recharge or replace battery.
4. Console is damaged. Contact your dealer.

### ROW FAILURE OR HI/LOW ALARM WHEN ROW IS PLANTING PROPERLY

#### Probable Cause

1. Seed sensor coated with dirt
2. Faulty sensor or harness
3. Defective console

#### Corrective Action

1. Clean sensor using a dry bottle brush.
2. Trigger sensor and observe troubleshooting LED. If sensor does not have LED, swap harness connection with adjacent sensor to determine if sensor or harness is damaged. Replace sensor or harness.
3. Console is damaged. Contact your dealer.



## HOPPER ALARM DOES NOT SOUND WHEN HOPPER IS EMPTY

### Probable Cause

1. Hopper sensor coated with dirt
2. Faulty sensor or harness shorted to ground
3. Defective console

### Corrective Action

1. Clean sensor using a dry bottle brush.
2. Swap harness connection with another sensor to determine if sensor or harness is damaged. Use service screen if another sensor is not available. Replace sensor or repair harness.
3. Console is damaged. Contact your dealer.

## HOPPER ALARM SOUNDS WHEN HOPPER IS FULL

### Probable Cause

1. Faulty sensor or harness open
2. Defective console

### Corrective Action

1. Swap harness connection with another sensor to determine if sensor or harness is damaged. Use service screen if another sensor is not available. Replace sensor or repair harness.
2. Console is damaged. Contact your dealer.

## SYSTEM VOLTAGE ALARM

### Probable Cause

1. Low battery voltage
2. Poor battery connection
3. Damaged harness

### Corrective Action

1. Console voltage must be at least 10 V. If low, recharge or replace battery.
2. Be sure connections are clean and tight. Inspect harness for damage.
3. Check all harnesses for pinches or breaks that may cause power or 8 V-sensor power short to ground.





## ACCESSORY ALARM SOUNDING WHEN SHAFT, FAN, OR FLOW IS WORKING

### Probable Cause

1. Sensor failure
2. Wrong calibration number
3. Incorrect limits
4. Defective console

### Corrective Action

1. Shaft, fan, or flow sensor not operating. Replace defective sensors.
2. Sensor calibration number is incorrect. Check calibration number in accessory set-up screen.
3. Sensor limits are incorrect. Check limits in accessory set-up screen.
4. Console is damaged. Contact your dealer.

## GROUND SPEED ALARM SOUNDS WITH FORWARD MOVEMENT

### Probable Cause

1. Ground speed sensor failure
2. Console failure

### Corrective Action

1. No ground speed sensor is detected, or planting is detected on at least one row with no ground speed. Replace faulty ground speed sensor.
2. Console is damaged. Contact your dealer.

## GROUND SPEED HIGH ALARM SOUNDING

### Probable Cause

1. Ground speed alarm set too low
2. Incorrect ground speed constant

### Corrective Action

1. Set ground speed alarm limit higher or to zero to disable.
2. Ground speed sensor has not been calibrated, RADAR sensor angle has changed, or incorrect sensor constant is entered. Use SPEED-AREA-DISTANCE mode to determine if speed is correct. If incorrect, re-calibrate speed constant (SPEED SET-UP SCREEN).



## SELF-TEST ALARM

**Probable Cause**

Console failure

**Corrective Action**

Console is damaged. Contact your dealer.



## CONNECTOR PIN-OUTS

### Console

Battery	
Pin Label	Description
Red Wire	Battery +12 V
Black Wire	Battery Ground

Ground Speed	
Pin #	Description
1	Ground (black)
2	Signal (green)
3	Power (red)
4	Sense (white)

Implement 1	
Pin #	Description
1	Row 1 (green)
2	Row 2 (brown)
3	Row 3 (blue)
4	Row 4 (orange)
5	Row 5 (yellow)
6	Row 6 (violet)
7	Row 7 (gray)
8	Row 8 (pink)
9	Row 9 (tan)
10	Row 10 (white/black)
11	Row 11 (red/black)
12	Row 12 (green/black)
13	Row 13 (orange/black)
14	Row 14 (blue/black)
15	Row 15 (black/white)
16	Row 16 (red/white)
17	Row 17 (green/white)
18	Row 18 (blue/white)
19	Row 19 (black/red)
20	Row 20 (white/red)
21	Row 21 (orange/red)
22	Row 22 (blue/red)
23	Row 23 (red/green)
24	8 V sensor power (red)
25	8 V sensor power (red)
26	Sensor return (black)
27	Sensor return (black)
28	Row 24 (orange/green)
29	Hopper 1 (white)
30,31	No connection
32	8 V power (red)
33	No connection
34	Sensor return (black)
35,36	No connection
37	Lift switch (black/white/red)

Implement 2	
Pin #	Description
1	Row 25 (green)
2	Row 26 (brown)
3	Row 27 (blue)
4	Row 28 (orange)
5	Row 29 (yellow)
6	Row 30 (violet)
7	Row 31 (gray)
8	Row 32 (pink)
9	Row 33 (tan)
10	Row 34 (white/black)
11	Row 35 (red/black)
12	Row 36 (green/black)
13-23	No connection
24	8 V sensor power (red/black/white)
25	8 V sensor power (red)
26	Sensor return (white/black/red)
27	Sensor return (black)
28	No connection
29	Hopper 1 (orange/black)
30	Hopper 2 (blue/black)
31	Shaft/Fan/Flow (black/white)
32	8 V power (red)
33	12 V switched power (green/white)
34	12 V return (black)
35	RS-232 Rx (blue/white)
36	RS-232 Tx (red/white)
37	No connection



## PARTS INFORMATION

<b>Monitor</b>	
<b>Description</b>	<b>Part Number</b>
CS-3000-36 monitor	46799-0350S1
Standard mounting bracket	46799-0151
3D adjustable mounting bracket	46799-0150
Fuse, AGC 5A	20112-0005

<b>Planter Harnesses and Cables</b>	
<b>Description</b>	<b>Part Number</b>
4-row harness	45841-0530
6-row harness	45841-0550
8-row harness	45841-0570
12-row harness	45841-0590
16-row harness	45841-1080
8-row squadron Y-cable	45968-0610
12-row squadron Y-cable	45968-0960
16-row squadron Y-cable	45968-0950
24-row squadron Y-cable	45968-0940
32-row squadron Y-cable	46799-1320

<b>Accessory and Extensions Harnesses</b>	
<b>Description</b>	<b>Part Number</b>
Accessory breakout harness	46799-1060
Hoppers and lift switch harness	46799-1240
16-row, 6 ft extension harness	45841-0810
16-row, 15 ft extension harness	45968-0320
16-row, 30 ft extension harness	45968-0321
32-row, 15 ft extension harness	45841-0820
32-row, 30 ft extension harness	45841-0790